

# ARES AR-001



Automatic Electric Airsoft Gun Instruction Manual • Always read through this manual before operation

## SAFETY

- DO NOT MODIFY OR ALTER YOUR AIRSOFT GUN. Attempts to modify the airsoft gun in way may make your airsoft gun unsafe to use, cause serious injury or death and will void the warranty.
- Always check to see if the airsoft gun is "ON SAFE" and unloaded when getting it from another person or from storage.
- Always keep the airsoft gun "ON SAFE" until you are ready to shoot in a SAFE DIRECTION.
- Misuse or careless use may cause serious injury.
- Do not look into the gun muzzle.
- Do not ever point the airsoft gun at anything you do not intend to shoot.
- You and other with you should always wear shooting glasses to protect your eyes.
- If your reading or prescription glasses are not safety glasses, make sure you wear shooting glasses over your regular glasses.
- Do not put the airsoft gun away loaded. Make sure ALL of the plastic BBs are unloaded from the airsoft gun.
- Do not shoot at hard surfaces or at the surface of water. The plastic BBs may bounce off or ricochet and hit someone or something you had not intended to hit. If the plastic BBs should happen to hit a hard surface, do not reuse those plastic BBs because they could cause possible damage to your airsoft gun.
- Use 6 mm plastic BBs only.
- Always put the airsoft gun in a case or bag when you carrying it.
- Always store this airsoft gun in a secure location and at the places out of reach by children.
- Always treat the airsoft gun as though it is loaded and with the same respect you would a firearm.
- Using unauthorized repair centers or modifying the function of your airsoft gun in any way may be unsafe and will void your warranty.
- We are not responsible for any malfunction, accidents, injuries or repair cost resulting from misuse, or by disassembly and modification of the airsoft gun.



# FIRING MODE

SINGLE

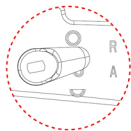

AUTO

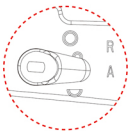

SPRING RELEASE

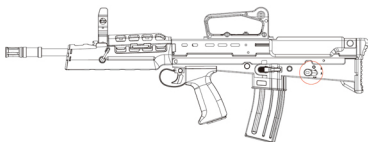
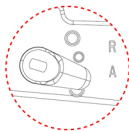

*\*Must pull the sector back to R or A position after release the spring*

# HOP-UP ADJUSTMENT

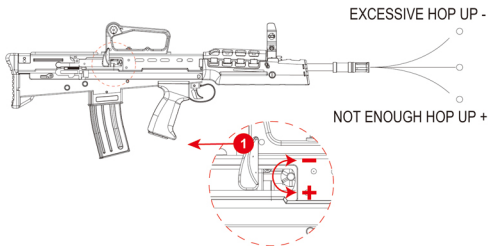

# SAFETY

FIRING POSITION

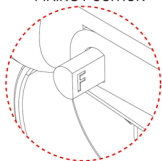

SAFETY POSITION

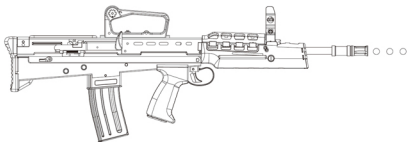
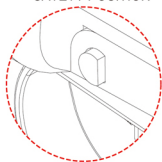

THE REPLACEMENT PARTS WILL BE AVAILABLE AT OURS LOCAL DISTRIBUTOR AND DEALERS

# INSERT BATTERY

Use the specified battery for your gun.  
9.6v 1500mah mini (2/3a) nunchuck

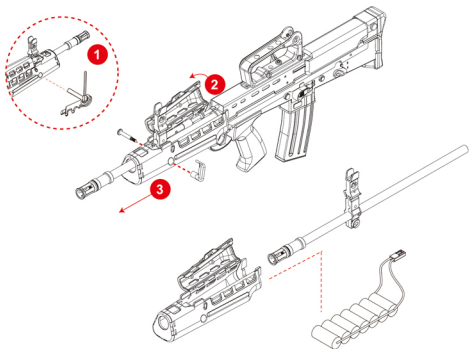

# SETTING THE MAGAZINE

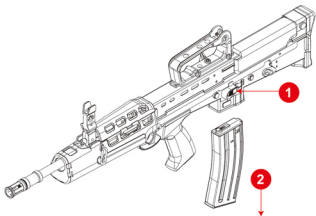

# OPTIONAL ACCESSORIES

## FULL METAL 4 X SUSAT

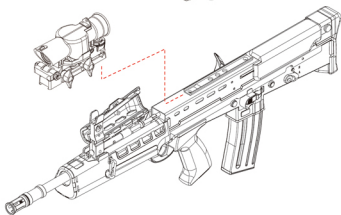
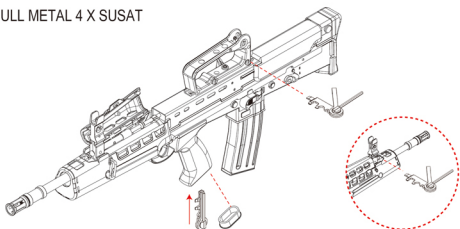

### Susat adjustment:

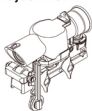

Loose the nut

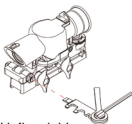

Adjust left or right

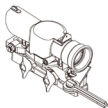

Adjust up or down



FOR MORE DETAIL INFORMATION PLEASE VISIT OUR WEBSITE

## DATA OF ARES AR-001 ELECTRIC GUN

### AR-001

Bolt Locking & Functional Bolt Catch



### FEATURES

- All New Molding
- Steel Stamping Process
- Metal Gearbox
- Bolt Lock / Release Function
- Easy Power Upgrade

<b>BATTERY:</b>	8.4V 3300mAh
<b>MAGAZINE CAPACITY:</b>	130rds (6mm BB)
<b>MODE:</b>	Full Auto / Semi / Safe
<b>MATERIAL:</b>	Nylon Fiber + Steel
<b>MOTOR:</b>	High Torque Flat Motor
<b>HOP-UP:</b>	Adjustable
<b>LENGTH:</b>	773mm
<b>WEIGHT:</b>	4200g
<b>VELOCITY:</b>	350-380FPS



Manufacturer & Brand Owner : Forever Good (Hong Kong) Ltd.



Worldwide:

Ares Website: <http://www.aresairsoft.com>

General Enquiries: [ares@aresairsoft.com](mailto:ares@aresairsoft.com)

North America: ZShot

Exclusive Distributor - <http://www.ZShot.com>

Dealer Inquires: [Sales@ZShot.com](mailto:Sales@ZShot.com) Technical Support: [Support@ZShot.com](mailto:Support@ZShot.com)